

VIDEOTREC Series Bracket

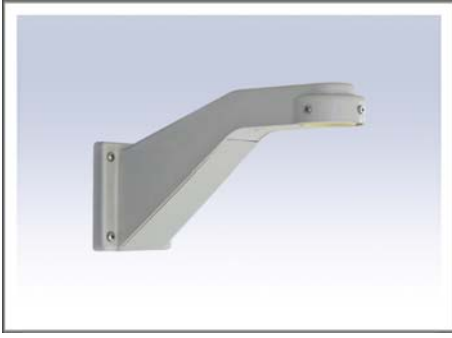

VT-9001 Wall Mount Bracket

- Material: ABS
- Mounting Method: Wall
- Use Scope: Suitable for VT-12W / VT-17W Series

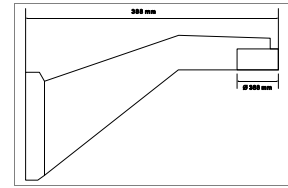
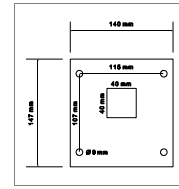

VT-9002 Pole Mount Bracket

- Material: Steel
- Mounting Method: Bracket adapters are designed for mounting on columns
- Use Scope: Suitable for VT-9009

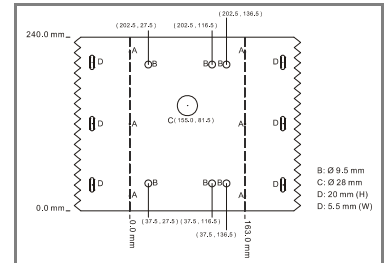
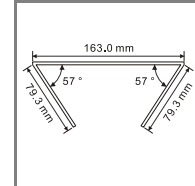

VT-9003 Goose's Neck Bracket

- Material: Steel
- Mounting Method: Wall
- Use Scope: Suitable for VT-16W

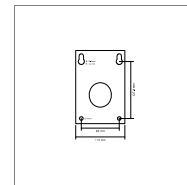
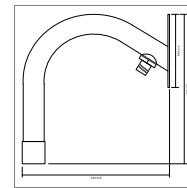

VT-9004 Pendant Mount Bracket

- Material: Steel
- Mounting Method: Pendant
- Use Scope: Suitable for VT-12W / VT-17W Series

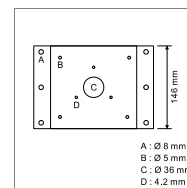

VIDEOTREC Series Bracket

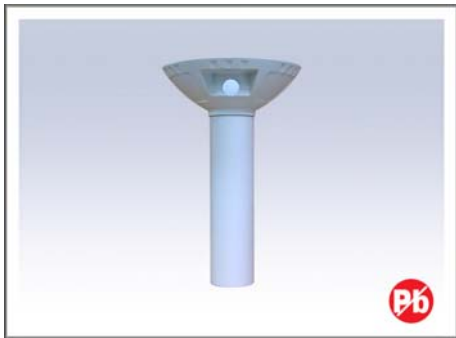

VT-9006 Pendant Mount Bracket

- Material: Aluminum
- Mounting Method: Pendant
- Use Scope: Suitable for VT-27W、VT-27WN Series

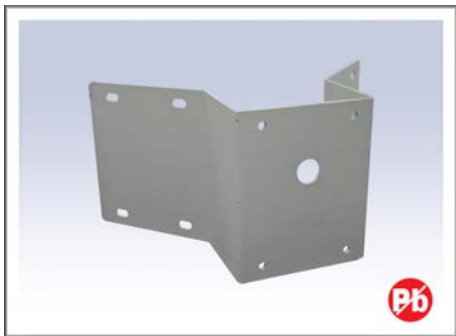
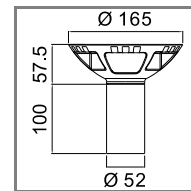

VT-9007 Outdoor 90° Corner Adapter

- Material: Aluminum
- Mounting Method: Wall
- Use Scope: Suitable for VT-16W
- Wall Bracket (VT-9009N) Option

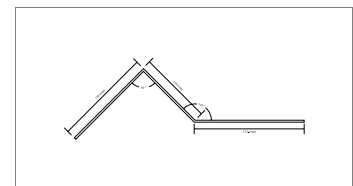
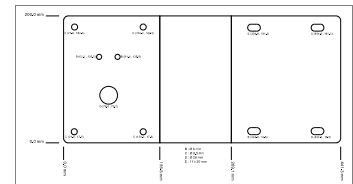
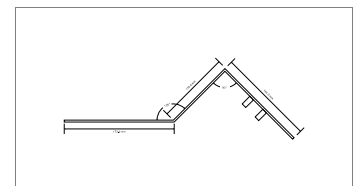
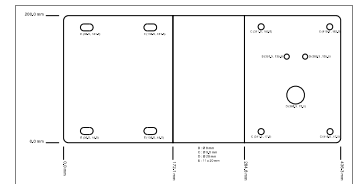

VT-9008 Indoor 90° Corner Adapter

- Material: Aluminum
- Mounting Method: Wall
- Use Scope: Suitable for VT-16W
- Wall Bracket (VT-9009N) Option

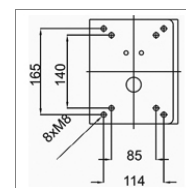
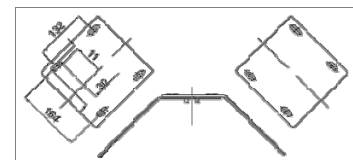

VT-9009N Wall Mount Bracket

- Material: Aluminum
- Mounting Method: Wall
- Use Scope: Suitable for VT-16W / VT-17W Series

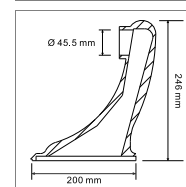

VIDEOTREC Series Bracket



VT-9010 Power Box

- Material: Aluminum
- Mounting Method: Wall or Pendant
- Use Scope: Suitable for VT-16W
- A stainless steel retaining cable
- Wall Bracket & Enclosure (Option)

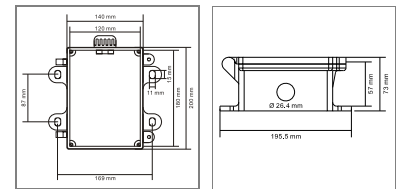

VT-9011 Pendant Mount Bracket

- Material: Aluminum and Steel
- Mounting Method: Pendant
- Use Scope: Suitable for VT-16W / VT-17W Series
- A stainless steel retaining cable

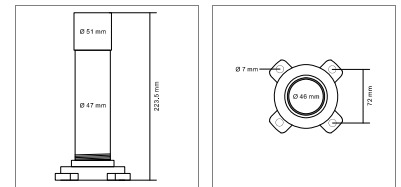

VT-9013 Housing Bracket

- Material: Aluminum
- Max. Load: 10kg
- Dimension: 85 x 100 x 285 mm
- Swivel Angle: 360°
- Tilt Angle: 90°
- Packing: 20pcs in one carton

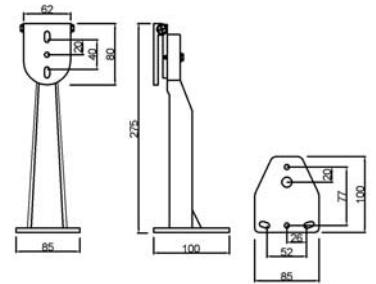

VT-9014 Camera Bracket

- Material: Aluminum
- Max. Load: 10kg
- Dimension: 100 x 95 x 260 mm
- Swivel Angle: 360°
- Tilt Angle: 90°
- Packing: 20pcs in one carton

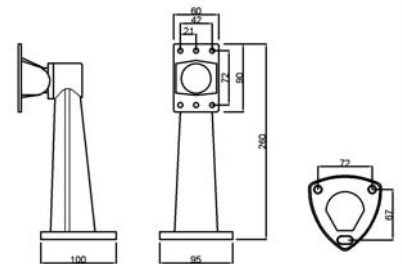

VT-9015 Camera Bracket

- Material: Aluminum
- Max. Load: 10kg
- Dimension: 73 x 93 x 280 mm
- Swivel Angle: 360°
- Tilt Angle: 90°
- Packing: 20pcs in one carton

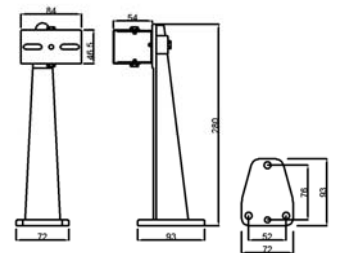

Copyright by 2007 Eastel Taiwan, Inc.