

VIDEOTREC



Introduction

- 6" Aluminum Dome Enclosure, Suitable for outdoor and indoor installation.
- Double-Decked design strengthens the heat insulation.
- Build-in fan & heater make sure the mechanism works in a certain temperature. (Option)
- A stainless steel retaining cable.
- FEVE: durable environment, resistible acid & base, five years warrant. (Option)
- Internal support for camera or adjustment for speed dome and network camera.
- Transparent or Smoke cover. (Selectable)

ADAPTORS

	Models
AXIS	212 、 215 、 225 FD 、 216 Series
GANZ	ZN-PT304
JVC	VN-C215V
PANASONIC	BB-HCE481 、 BB-HCM381 、 BB-HCM580 、 BB-HCM581 、 WV-NF284
SAMSUNG	SID-450 、 SID-500 、 SPD-1000 、 SVD-4020 、 SVD-4120A 、 SVD-4300
TOSHIBA	IK-WB21A 、 IK-WB21E

TECHNICAL DATA

ENVIRONMENT

Fan : 40°C ON , 30°C OFF

Heater : 5°C ON , 15°C OFF

In 12V DC , Consumption 12W Max.

COMPLIANCE TO

CE According to EMC DIRECTIVE 89/336/EEC
(EN 61000-6-3 / EN 50130-4)

FCC According to FCC Part 15 Class B (DoC)

IP66 According to IP930100 (EN : 1038)

RoHS According to CS / 2006 / 70002 (SGS)

ACCESSORIES

P1230 EN Power Supply in 12V DC for En

P1230 USA Power Supply in 12V DC for USA

P1230 EU Power Supply in 12V DC for EU

P1230 JP Power Supply in 12V DC for JAPAN

Fan Assisted Heater in 3A DC

VT-16W Dome Enclosure

RELATED PRODUCTS

VT-9009N Wall Mount	C601 Metal Parts
VT-9010 Power Box	C602 Metal Parts
VT-9011 Pendant Mount	C603 Metal Parts
VT-9002 Pole Adaptor for VT-9009N	
VT-9007 Corner Adaptor for VT-9009N	

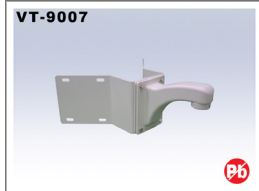
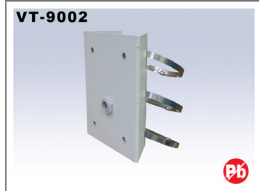

DIMENSIONS

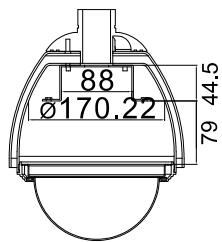
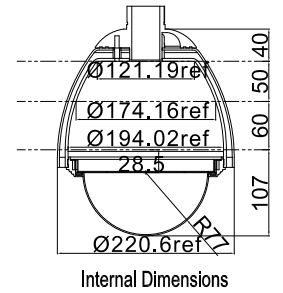
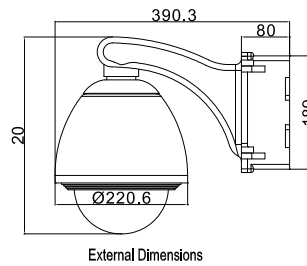
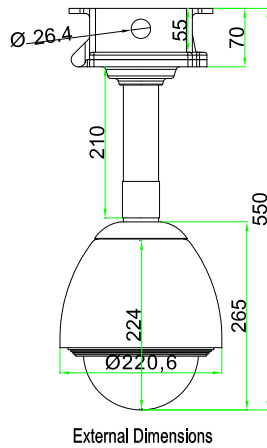
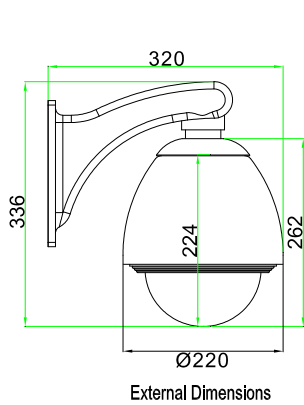

For Network Camera & Speed Dome

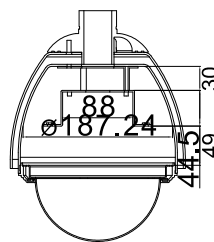
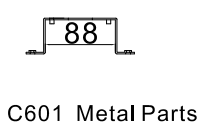

For Network Camera & Speed Dome

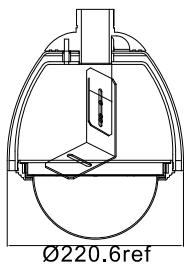
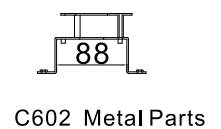

For Fixed Camera

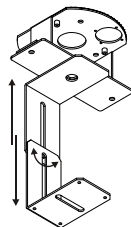

C603 Metal Parts

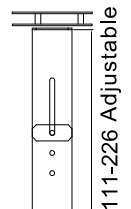
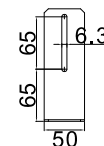

Unit Weight:
6.8 kg (Box), 5.1 kg (No Box)

Package Weight:
7.8 kg (Box), 6.1 kg (No Box)

Package Dimensions (B x H x L):
50 x 35 x 28 cm (Box), 43 x 26 x 35 cm (No Box)

Copyright by 2007 Eastel Taiwan, Inc.